

# SATATYA MIDR20FL36CWS

2MP IR Dome Camera with 3.6mm Lens



## SATATYA MIDR20FL36CWS

2MP IR Dome Camera with 3.6mm Lens

Matrix Professional Series Dome IP Cameras are built using superior components such as Sony STARVIS sensor and higher MTF lens to offer unmatched image quality especially during the low light conditions. Powered by True WDR algorithm, these cameras offer consistent image quality even in highly varying lighting conditions. Built in intelligent analytics including Intrusion Detection, Trip Wire, etc. ensure real-time security. Moreover, H.265 compression and Automatic Motion based Frame Rate Reduction save bandwidth and storage up to 50%.

### USP



SONY STARVIS  
SENSOR



H.265



IVA



HIGHER FIELD  
OF VIEW



SMART  
STREAMING



ADAPTIVE  
STREAMING



TRUE WDR



NAS

### CERTIFICATION



Customer Care: 1800-258-7747

E-mail: [Inquiry@MatrixComSec.com](mailto:Inquiry@MatrixComSec.com)

[www.MatrixVideoSurveillance.com](http://www.MatrixVideoSurveillance.com)

Made in India

# SATATYA MIDR20FL36CWS

2MP IR Dome Camera with 3.6mm Lens



TECHNICAL SPECIFICATIONS	
IMAGE SENSOR	
Resolution	2 MP (1920 x 1080)
Sensor Type and Size	1/2.8" SONY - CMOS 2MP Active Pixel Progressive Scan, Back Illuminated Image sensor (EXMOR Technology - STARVIS Series)
LENS	
Minimum Illumination	Colour - 0.01 Lux @ F1.2 (AGC ON) Monochrome - 0 Lux
Focal Length	3.6mm
Focus Range	0.3m to infinity
Field of View (FOV)	HFOV - 90° VFOV - 47° DFOV - 110°
Lens Mount	M12
Focus	Fixed focus
Aperture (F#)	F 1.2
Iris Type	Fixed
IR Range	30m
IR Led Wavelength	850nm
IR Switching	Auto/ Manual
HARDWARE SPECIFICATIONS	
SD Card	Up to 512GB
Camera Adjustment Angle	Pan: 0° to 360° Tilt: 0° to 75° Zoom: 0° to 360°
IMAGE AND VIDEO	
No of Stream Profiles	4
Stream Profiles	Profile 1: 1080p(2MP)/720p/D1/2CIF/CIF/QCIF up to 30 fps (H.265/H.264) Profile 2: D1/2CIF/CIF/QCIF up to 30fps (H.265/H.264) Profile 3: 1080p(2MP)/720p/D1/2CIF/CIF/QCIF up to 5 fps (MJPEG) Profile 4: 720p/D1/2CIF/CIF/QCIF up to 30 fps (H.265/H.264/MJPEG)
Available Resolutions	1920 x 1080, 720p, D1, 2CIF, CIF, QCIF
Max Resolution	1920 x 1080
Bitrate	128 kbps-8Mbps
Bitrate Type	CBR, VBR
Video Compression	H.265, H.264, MJPEG
Frame Rate	1-30fps

# SATATYA MIDR20FL36CWS

2MP IR Dome Camera with 3.6mm Lens



Shutter Speed	1/25-1/34000
Adaptive Streaming	Yes
ONVIF Profiles	Both S and G
Edge Recording	Yes
Alarm Recording	Pre and Post
Motion Recording	Yes
Video Parameters	Snapshot, Region of Interest (ROI), BLC, Day/Night Settings
Privacy Masks	3
WDR	True WDR (120dB)
SNR	71db
Image Enhancement	Saturation/ Contrast/ Sharpness/Brightness/Auto Exposure
DNR	2D &3D
Video Analytics	Motion/No Motion Detection, Tamper Detection, Trip/No Trip Detection, Object Intrusion/Zone Intrusion, IP Conflict, Network Disconnect, Storage Full, Time Triggered
<b>EVENTS AND ACTIONS</b>	
Upload Image	SD, NAS, FTP
Upload Clip	SD, NAS, FTP
Notifications	E-mail, SMS, TCP
<b>PROTOCOLS SUPPORTED</b>	
Supported protocols	TCP/IP, HTTP, DHCP, DNS, DDNS, RTP, RTCP, RTSP, PPPOE, SMTP, NTP, HTTPS, TLS/SSL, FTP, ICMP, IGMP v2 & v3
Web Viewer	Supported in IE 8.0-11.0, Firefox 15.0-47.0, Chrome 20.0-54.0
Plugins	IE: Matrix ActiveX Chrome: VLC plugin (2.0.4) and Quicktime (7.7.5) Mozilla: VLC Plugin (2.0.4) and Quicktime (7.7.5)
<b>OPERATING PARAMETERS</b>	
Power Supply	12V (DC); 802.3af (PoE)
Power Consumption	<5.5W
Operating Humidity	Less than 90% RH (non-condensing)
Operating Temperature	0°C to 50°C
Storage Temperature	-20°C to 50°C
<b>PHYSICAL PARAMETERS</b>	
Communication interface	10Base-T/100BaseTX Ethernet (RJ-45)
Weight	450gm
Colour	Pantone 7527C
Dimensions	110mm x 85mm (Length x Width)
Storage	NAS, SD Card
Certifications	BIS, CE, IP66, FCC Part-15 Class-B, ONVIF S & G, IK10

# SATATYA MIDR20FL36CWS

2MP IR Dome Camera with 3.6mm Lens



## DIMENSIONS (in mm)

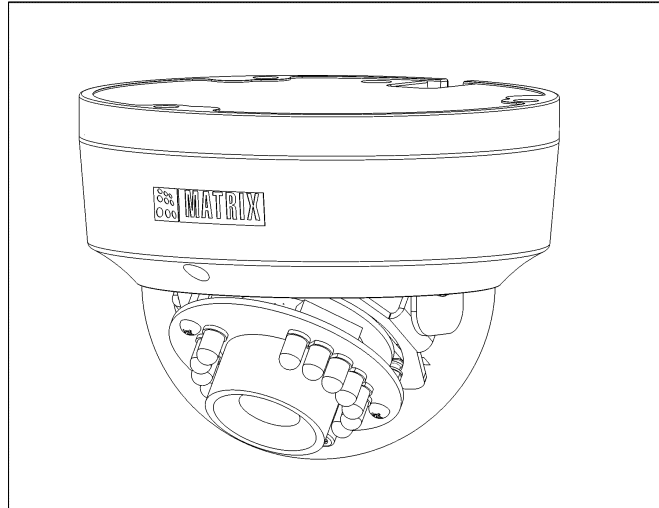
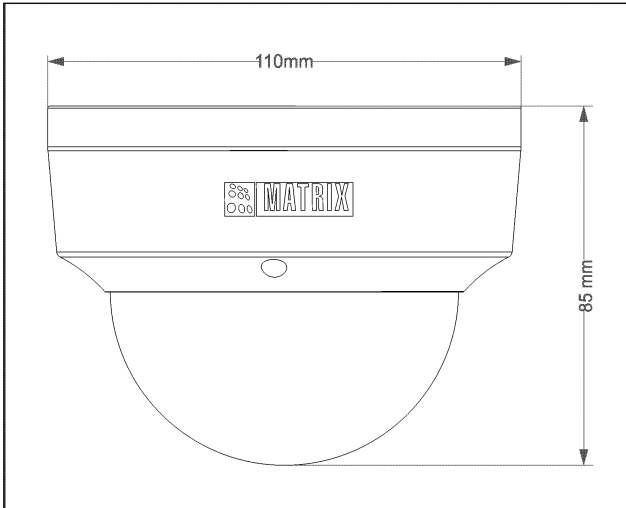

### ABOUT MATRIX

Established in 1991, Matrix is a leader in security and telecom solutions for modern businesses and enterprises. Matrix, an innovative, technology driven and customer focused organization, is committed to keep pace with the revolutions in security and telecom industries. With more than 40% of its human resources dedicated to the development of new products, Matrix has launched cutting-edge products such as Unified Communications, IP-PBX, Universal Gateways, Convergence, VOIP Gateways, GSM Gateways, IP Video Surveillance, Access Control and Time-Attendance. These solutions are feature-rich, reliable and conform to the international standards. Having global footprints in Europe, North America, South America, Africa and Asia through an extensive network of more than 1000 system integrators, Matrix ensures that the products serve the needs of its customers faster and longer. Matrix has gained trust and admiration of customers representing the entire spectrum of industries. Matrix has won many national and international awards for its innovative products.

\* Specifications are subject to change without prior notice.